



Čeština  
Dansk  
Deutsch  
Eesti  
Ελληνικά  
English  
Español  
Français  
Italiano  
Latviski  
Lietuviškai  
Magyar  
Nederlands  
Norsk  
Polski  
Português  
Slovenčina  
Slovenski  
Suomi  
Svenska

# Leica StereoZoom<sup>®</sup>

User Manual

*Leica*  
MICROSYSTEMS

# Contents

	Page
<b>Information</b>	
Safety rules .....	4
Symbols .....	7
Description: Features, lens system .....	8
Models .....	10
<b>Design</b>	
System diagram .....	12
Incident-light equipment .....	14
Transmitted-light equipment .....	14
Objectives .....	16
Eyepieces .....	16
High-performance lighting .....	17
Leica L2 cold-light source .....	17
Graticules .....	18
Camera assembly for Leica S6 D and S8 APO .....	20
<b>Operating</b>	
Controls .....	22
Interpupillary distance and exit pupil .....	23
Eyecups .....	24
Setting working distance and focusing .....	24
Zoom magnification changer .....	25
Diopter adjustment .....	28
Photography with Leica S6 D and S8 APO .....	32
<b>Special notes</b>	
What do I do if .....	33
Care and maintenance .....	34
Calculating total magnification and field diameter .....	37
Optical data .....	38
Dimension .....	41
Leica Microsystems .....	47

## Dear Customer

Thank you for the trust you have shown in choosing one of our products. We hope you will have much enjoyment and success with your new stereomicroscope from Leica Microsystems.

With its new StereoZoom® line the Swiss Stereomicroscopy Business Unit offers a comprehensive range of stereomicroscopes for every application. The Leica L2 cold-light illuminator – also new – transforms any of the instruments into a compact, streamlined complete outfit of modern design. Possible applications range from inspection and assembly work, OEM and schools to quality assurance functions. The stereomicroscopes, cold-light source and stand are all antistatic to protect against ESD. A Terminator version is available for problematic working areas in electronics.

One of our major development goals was to make our new StereoZoom® line simple and intuitive to use. Nevertheless, please take the time to read these instructions. They will familiarize you with your stereomicroscope's advantages and enable you to use it to best effect. If you have questions at any time, please contact your Leica representative or Leica Microsystems (Switzerland) Ltd. We will be glad to help you. We place great emphasis on customer service – before and after purchase (see p. 47).

Leica Microsystems (Switzerland) Ltd  
Stereo & Macroscopy Systems  
[www.stereomicroscopy.com](http://www.stereomicroscopy.com)

# Safety rules

- General instructions** Read the instructions for use and safety instructions before putting the stereomicroscope into operation.
- Intended application** Leica S4 E, S6 E, S6, S6 T, S6 D and S8 APO stereomicroscopes are precision optical instruments for making technical and scientific objects, object details or specimens more easily visible by means of magnification. Stands, illuminators and accessories complete the equipment.
- Improper use**
- Use of the instrument other than in the manner described in these instructions could result in personal injury or material damage.
  - The Leica S series stereomicroscopes must not be used for examining and operating on the eye.
  - Never fit other equipment connectors or dismantle optical systems and mechanical parts unless the user manual gives express instructions for doing so.
- Place of use**
- The Leica S4 E, S6 E, S6, S6 T, S6 D and S8 APO stereomicroscopes are intended primarily for indoor use.
  - If used outdoors the stereomicroscope must be protected against dust and moisture. Leica Microsystems electric illuminators and stands must not be used outdoors.
- Installation in third-party products** The following must be observed when installing Leica products in third-party products:  
The manufacturer of the basic system or the person putting the product into circulation is responsible for compliance with existing safety regulations, laws and directives.
- Use in Clean Rooms** The Leica S series can be used in clean rooms without any problems and they can be cleaned as described on page 35. Please observe the following rules:
- Do not clean our stereomicroscopes and accessories in a different manner from that described in this user manual. Do not use unsuitable cleaning agents, chemicals and techniques. Do not clean painted surfaces and accessories with rubber parts with chemicals.  
This can damage the surfaces. Particles or grindings can contaminate the specimen.
  - If the customer cleans our instruments with chemicals without our written approval he will do it at his own risk.
  - In most cases we can offer special solutions on request. Some products can be modified or we could recommend other accessories for use in clean rooms.
- Service work** Repair work must only be carried out by service engineers trained by Leica Microsystems. Only original spare parts from Leica Microsystems are to be used.
- Obligations of the operator**
- Make sure that personnel using this stereomicroscope have read and understood these instructions, especially the safety instructions.
  - Take steps to ensure that Leica S4 E, S6 E, S6, S6 T, S6 D and S8 APO stereomicroscopes are only operated, serviced and repaired by authorized and trained personnel.

# Safety regulations



Workplaces with stereomicroscopes facilitate and improve the viewing task, but they also impose high demands on the eyes and holding muscles of the user. Dependent upon the duration of uninterrupted activity, this may lead to asthenic trouble and muscular-skeletal pain so that suitable measures must be taken to reduce the strain:

- perfect design of workplace, work content and work process (frequently changing activities).
- detailed introduction of the personnel while considering ergonomic and organizational work-related aspects.

The ergonomic optics concept and the design of the Leica S series aim at limiting the strain on the user to the lowest possible level.



Direct contact with eyepieces can be a potential transmission path for bacterial and viral infections of the eye. Users should be made aware of the potential risk of infection. The risk can be kept at a minimum by using individual eyepieces or attachable eyecups (see p. 17).

## Electrically operated equipment

### Liquids

Handle liquids carefully.

Liquids spilt on the instrument

- can cause the stereomicroscope and other equipment to become electrically live and injure persons,
- can cause damage to the instrument.

### Mains cable

Check regularly to ensure that the mains cable is undamaged and avoid jerking or pulling the cable hard.

Faulty mains cables

- can injure persons,
- can cause the stereomicroscope and other equipment to become electrically live and injure persons.

### Cable routing

Ensure the cable is not in a position where someone could accidentally catch it, otherwise the instrument could tip over and fall, damaging itself or other equipment, or injuring people nearby.

### Opening the instrument

Electrical equipment may only be repaired by authorized Leica personnel.

Disconnect the mains cable before opening the instrument. Touching the open instrument when voltage is applied may result in injury.

**Mains voltage** Make sure that the instrument is set for the correct mains voltage. Incorrect setting can damage the instrument.

**Connections** Only devices with the correct power rating may be connected to the transformers. Overloading can result in damage to the instrument.

**Changing lamps**

- Disconnect the mains cable from the mains supply before changing lamps.
- Never put your hand in the lamp housing or transmitted-light stand when the instrument is connected to the mains.
- Wait for filament lamps to cool down before changing. Touching hot filament lamps can result in burns.

**Statutory regulations** Observe all statutory accident prevention and environmental protection requirements.

**Disposal** National laws and regulations must be observed for the disposal of these products.

**EC declaration of conformity** Electrically operated accessories for Leica S4 E, S6 E, S6, S6 T, S6 D and S8 APO stereomicroscopes are manufactured using state-of-the-art technology and carry an EC declaration of conformity.

# Symbols

## User Manual

Your instrument is accompanied by a printed English user manual. Additional language versions and information can be found on the interactive CD-ROM. User manuals and updates are available for download on our homepage at [www.stereozoom.com](http://www.stereozoom.com).

You will find the address of the closest local representative as well as valuable information about products and services from Leica Microsystems on our homepage at [www.leica-microsystems.com](http://www.leica-microsystems.com)

## Symbols in this manual



### Safety warnings

This symbol denotes information that must be read and acted upon without fail.

**Disregarding safety warnings can put persons at risk!**



Disregarding safety warnings can also result in malfunctioning or damage to the instrument.



Warning against exposed hot points, e.g. filament lamps.

**Risk of burns if disregarded!**



### Important information

This symbol denotes additional information or explanations to assist understanding.

### Action

► This symbol denotes action to be taken.

### Additional information

- This symbol denotes additional information or explanations.

# Description

## **Greenough optical system**

The optical system of the Leica StereoZoom® line consists of two beam paths converging at 12°. Since the pairs of objectives are very close together, the stereomicroscopes can be constructed very “slim” towards the base. This has a number of advantages: less space required for use on bonders and machines, unimpeded working on the object, plenty of room for tools, free view of the object field.

The Greenough system provides a low-cost solution for correcting aberrations such as chromatism, curvature of the field of view and distortion. On the new Leica StereoZoom® line the optimally corrected centre of the objective is used for the image. This results in excellent optical performance with large, flat, distortion-free fields of vision and high-contrast images with maximum chromatic correction.

## **Protection against ESD**

The Leica S4 E, S6 E, S6, S6 D and S8 APO stereomicroscopes including cold-light source and stand are made of antistatic material with a surface resistance of  $2 \times 10^{11}$  ohm/square and a discharge time from 1000V to 100V of under 2 seconds.

The Leica S6 T Terminator for problematical work areas and the T incident-light stand are made of antistatic material with a surface resistance of  $10^2$ – $10^6$  ohm/square and a discharge time from 1000V to zero of under 0.1 seconds.

## **Photography**

The Leica StereoZoom® S6 D and S8 APO models are equipped with a built-in video/photo tube that allows for simple, quick setting up of digital, film and analog video cameras.



**World first** Leica StereoZoom® S8 APO is the first stereomicroscope on the market with completely apochromatic corrected Greenough system. Apochromatic optics corrects perfectly chromatic aberrations, eliminates interfering color fringes and renders even the finest details ultra sharp. Contrast, brilliance, sharpness, resolution, color fidelity and reproduction accuracy are unsurpassed. The advantage of apochromatic correction is best observed in objects that have fine, low-contrast structures such as large animal cells, cilia plants or metallic microelectronic structures.

## Features

<b>StereoZoom®</b>	<b>Zoom</b>	<b>Magnification</b>	<b>Viewing angle</b>	<b>Extras</b>
Leica S4 E	4.8:1	6.3×–30×	38°	ErgoLens
Leica S6 E	6.3:1	6.3×–40×	38°	ErgoLens
Leica S6	6.3:1	6.3×–40×	60°	ErgoLens
Leica S6 T	6.3:1	6.3×–40×	38°	Terminator ErgoLens
Leica S6 D	6.3:1	6.3×–40×	38°	Video/photo tubes Ergonomic objectives
Leica S8 APO	8:1	10×–80×	38°	Apochromatic Greenough system Apochromatic zoom Apochromatic objectives Video/photo tube

StereoZoom® is registered as a trademark in the Principal Register of the US Patent and Trademark Office

**StereoZoom®  
Leica S4 E**



**StereoZoom®  
Leica S6 E**



**StereoZoom®  
Leica S6**



Leica Design  
by Christophe Apothéloz

**StereoZoom®  
Leica S6 T**



**StereoZoom®  
Leica S6 D**



**StereoZoom®  
Leica S8 APO**



# Design

1 StereoZoom®  
Optics carriers

2 Objectives

3 Eyepieces

4 Carriers/  
Focus arms

5 Focus columns

6 Incident-light bases

7 Transmitted-light  
bases

8 Stages

9 Stands  
(Swing arm,  
Flex arm)

## 3 Low Eyepoint Eyepieces

Eyepieces, fixed	Standard		ergonomic
	 10×/23	10 446 354	10 447 130
16×/16	10 446 356	10 447 134	
20×/12			

Eyepieces, adjustable*	Standard		ergonomic
	 10×/23	10 446 355	10 447 131
16×/16	10 446 357	10 447 135	
20×/12			

\* Adjustable eyepieces accept reticles

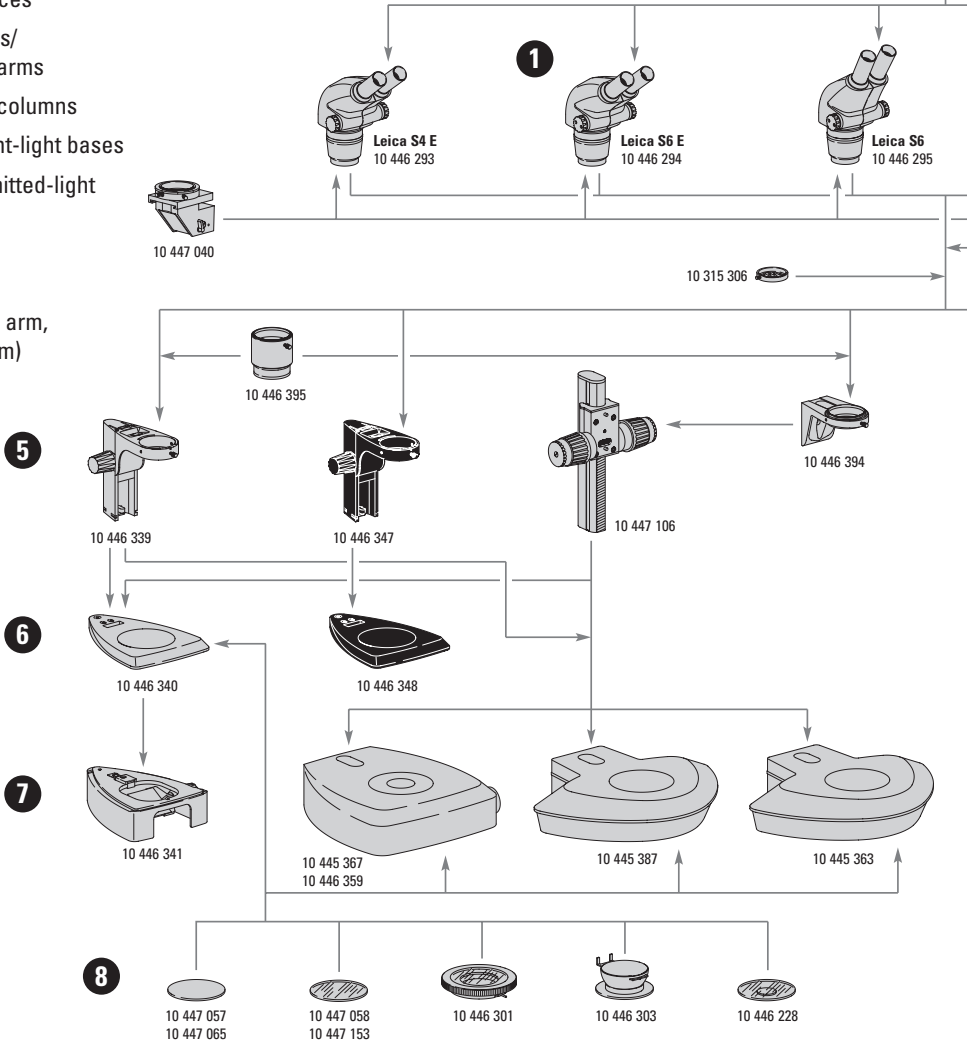

## High Eyepoint Eyepieces

### Eyepieces, fixed

ergonomic	
10×/23	10 447 136
16×/15	10 447 138

### Eyepieces, adjustable\*

ergonomic	
10×/23	10 447 137
16×/15	10 447 139
25×/9.5B	10 445 302
40×/6B	10 445 303

\* Adjustable eyepieces accept reticles

10 447 036

Spacing Ring required with eyepieces  
10 445 302, 10 445 303

Photo / Video documentation  
Leica DC cameras



**Leica S6 T**  
10 446 296

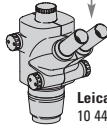

**Leica S6 D**  
10 446 297

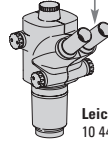

**Leica S8 APO**  
10 446 298

2

### Objectives for S8 APO

0.32×	10 446 334
APO 0.63×	10 446 335
APO 1.6×	10 446 336
APO 2×	10 446 337

### Objectives

#### for S4 E, S6 E, S6 T, S6 D

0.32×	10 446 316
0.5×	10 446 318
0.63×	10 446 319
0.75×	10 446 320
1.6×	10 446 321
2×	10 446 322

Lens shield	10 446 324
-------------	------------

### Adjustable Lens

0.3×–0.4×	10 446 325
-----------	------------

### Ergolenses

0.6×–0.75×	10 446 323
0.7×–1×	10 446 317

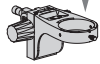

10 446 345



10 446 344



10 446 343



10 446 342

4

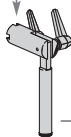

10 376 070

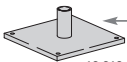

13 312 611

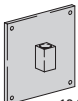

13 312 613



13 312 614

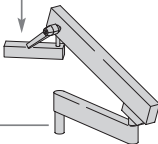

13 312 610

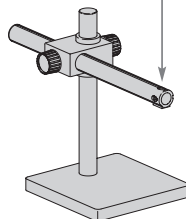

13 312 714

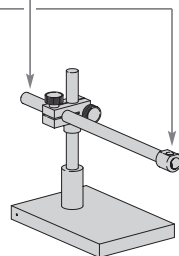

10 446 299

9

# Design, Basic equipment

## The components

- 1 Incident-light base with stage plate
- 2 Transmitted-light base with glass stage plate
- 3 Focus column with microscope carrier
- 4 StereoZoom® optics carrier
- 5 Optional additional objective
- 6 Eyepieces, fixed and/or adjustable

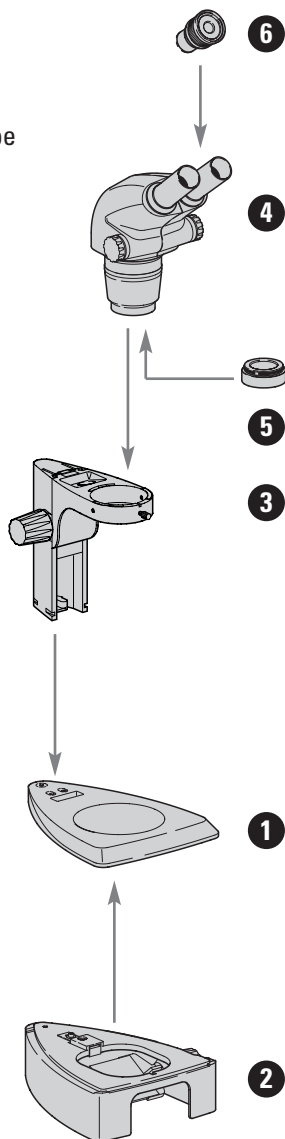

# Assembly



Never loosen the 3 screws on the right-hand side of the focus column.

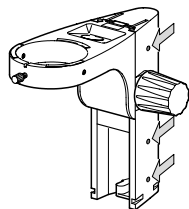

## Focus column → Incident-light base

- ▶ Remove stage plate.
- ▶ Insert 3 hexagon head screws through the underside of the baseplate and screw tight in the focus column.
- ▶ Replace stage plate.

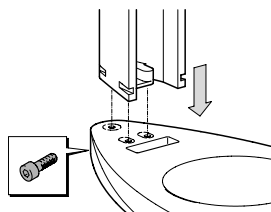

## Transmitted-light base → Incident-light base

- ▶ Remove glass stage plate.
- ▶ Undo locking device.
- ▶ Place incident-light stand on the transmitted-light base and engage in the connecting screw.
- ▶ Close locking device.
- ▶ Replace glass stage plate.

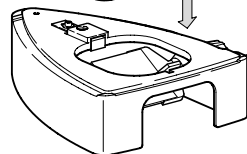
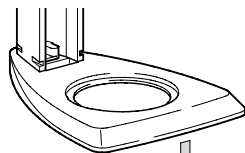
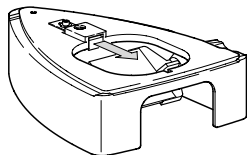

- ▶ Insert universal light guide in the socket at the back (see user manual for the Leica L2 cold-light source).

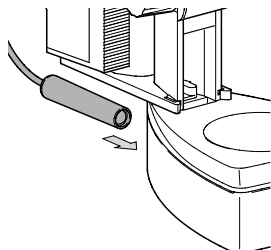

# Assembly

## Optics carrier → Stand

- ▶ Insert optics carrier carefully in the microscope carrier.
- ▶ Fix optics carrier in the desired position with the clamping screw.

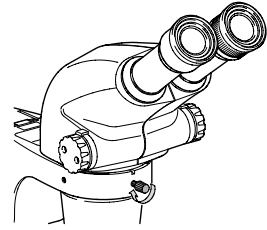

## Additional objective (optional) → Optics carrier

- ▶ Screw selected objective tight in counterclockwise direction.

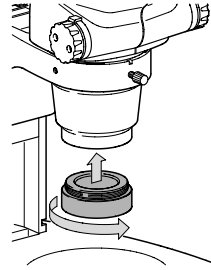

## Lens shield (optional)

- ▶ Screw the lens shield tightly into the thread on the StereoZoom® or onto the additional objective.

## Eyepieces → Eyepiece tube

- ▶ Push eyepiece into the eyepiece tube as far as it will go.
- ▶ Check that it sits firmly and snugly.

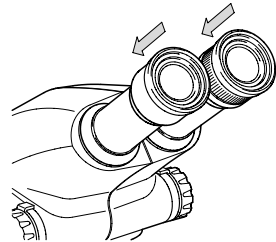

You can combine your StereoZoom® with a fixed and an adjustable eyepiece. Two adjustable eyepieces are required for equipment which has a reticle in an eyepiece for measurement or photography purposes. We recommend that you also equip the high-performance Leica StereoZoom® S8 APO with **two** adjustable eyepieces.



**Soft eyecups** The eyepieces are supplied with soft eyecups, which can be attached to achieve the following:

- Prevent eye infections if several users are working at the same instrument (see p. 5).
- Protect your glasses from being scratched.

**Leica L2 cold-light source → Stand**

With its fibre-optic light guides the Leica L2 cold-light source is the illumination of choice for the Leica S4 E, S6 E, S6 and S6 T stereomicroscopes. Matching adapters are available for connecting the Leica L2 cold-light source to various stereomicroscope stands and for standalone operation.

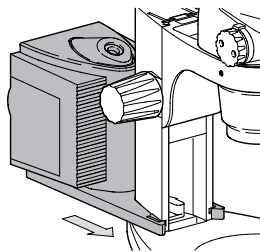

Detailed information on the construction and use of the Leica L2 can be found in the relevant user manual.



Please note that the universal light guide on the Leica S8 APO can only be used with the sideways-mounted lamp arm.

**High-performance lighting**

For higher requirements, e.g. for photography or in combination with the Leica S8 APO, we offer a diverse, high-performance transmitted light stand and low-voltage lighting. Please ask your Leica advisor about the options.

# Assembly

**Graticule → Adjustable eyepieces** The following graticules and stage micrometers are available for calibration:

Graticule 10mm/0.1mm

Graticule 5mm/0.1mm

Graticule 5mm/0.05mm

Graticule 100 div./0.002"

Graticule 100 div./0.001"

Graticule 150 div./0.0005"

Crosshair

Stage micrometer 50mm, 0.1/0.01mm divisions

Stage micrometer 1", 0.001" divisions

For photography, a 10× format reticle is available.



**Two** adjustable eyepieces are required for equipment which has a reticle in an eyepiece for measurement or photography purposes.

The graticules can be inserted into adjustable eyepieces and eyepieces for spectacle wearers:

► Ascertain with the aid of the stereomicroscope on which side the vacuum-metalized scale is located. The scale should be visible on the correct side.

► Pull out the insert from the bottom of the eyepiece and place it with the knurled side on the table.

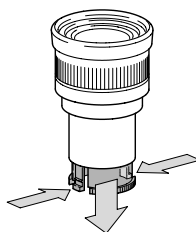

- ▶ Pick up the graticules at the edge so as not to leave fingerprints and slide into the holder from the side.

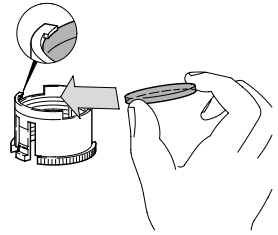

- ▶ Put the insert back into the eyepiece and press firmly in place.

- ▶ Insert the eyepiece into the eyepiece tube and line up the graticule by turning the eyepiece in the eyepiece tube.

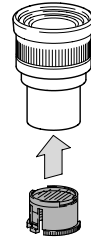

The measuring process is described in the “Measuring” instructions.

# Assembly

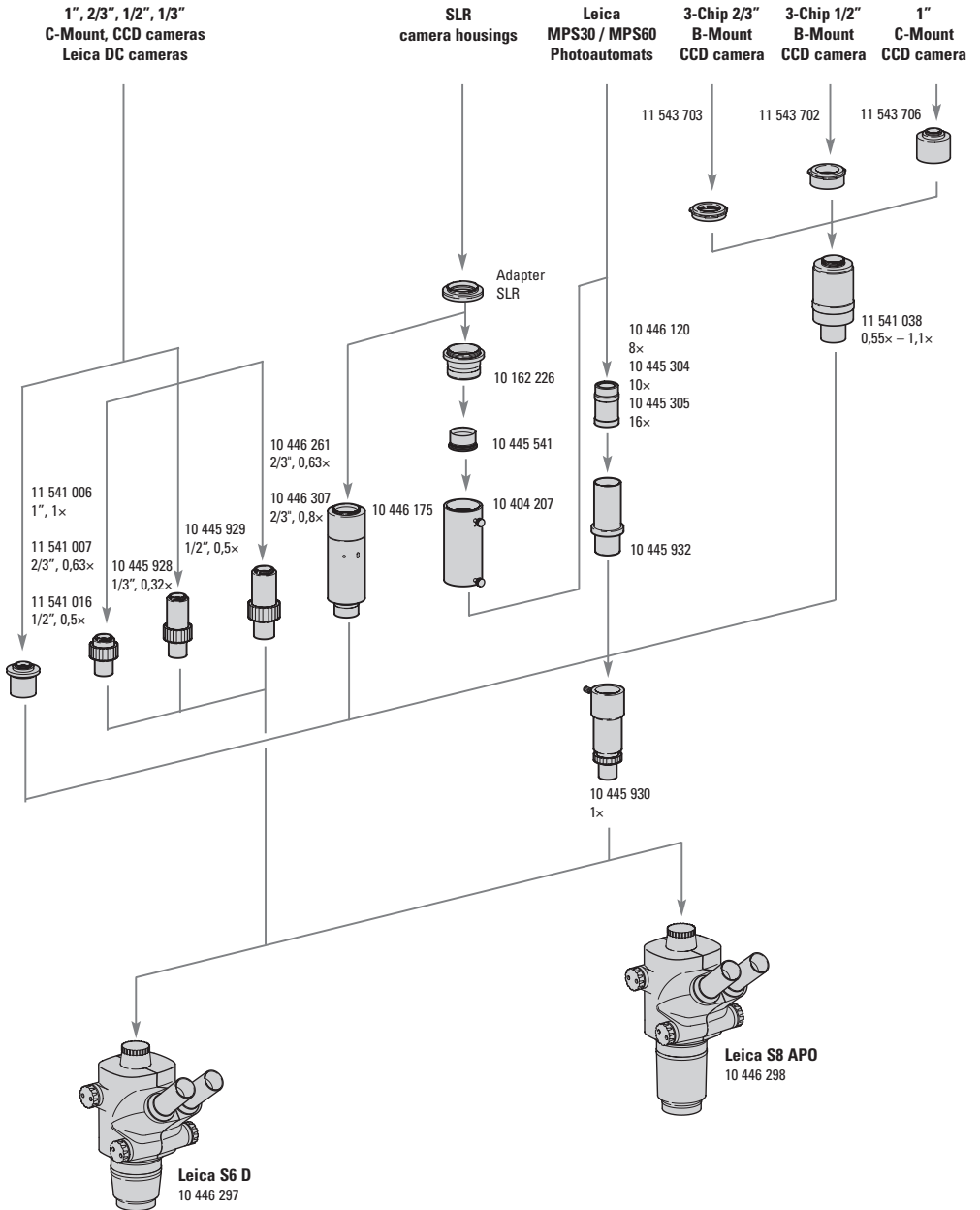

**Camera assembly for  
Leica S6 D and  
S8 APO**

Leica StereoZoom® S6 D and S8 APO are equipped with a built-in video/photo tube that allows for simple, quick setting up of digital, film and analog video cameras. Please ask your Leica advisor about the options.

You can find detailed information about Leica camera systems, accessories and image management software in the corresponding manuals.

- ▶ Remove the dust cover from the video/photo output.
- ▶ Always close the video/photo output with the dust cover if there is no camera attached.
  
- ▶ Attach appropriate video or photo objective, according to which camera is used (see scheme p.20).

**Format reticle**

The format reticle is used to test the sharpness and picture detail. Borderlines are displayed on the reticle for all film formats.



The left observation beam path and the photo output are aligned with one another. Always judge, therefore, the picture detail and the sharpness in the left eyepiece.

- ▶ Insert format reticle into an adjustable eyepiece (see p.18).
- ▶ Insert eyepiece with reticle into the left tube.

# Operating

## Overview

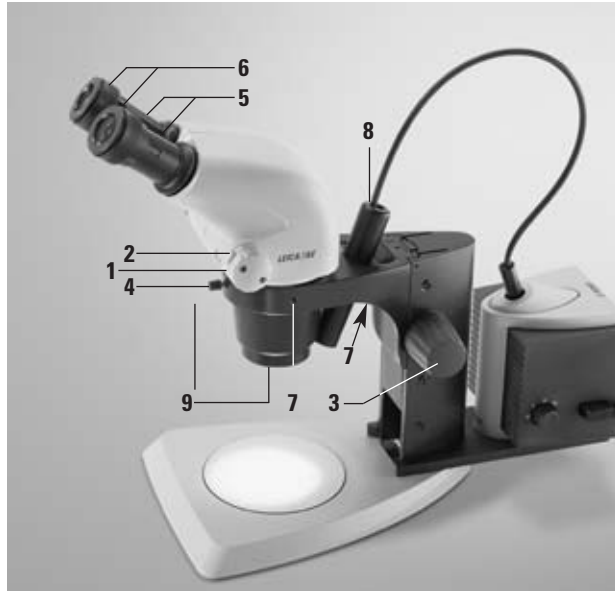

### Standard controls and their functions

- 1 Magnification changer, right-hand pinion knob with magnification scale
- 2 S6 models: zoom limiter stop
- 3 Focusing drive
- 4 Fixing screw  
fixes the optics carrier in the microscope carrier
- 5 Adjustable eyepiece tubes:  
Interpupillary distance adjustable from 55–75mm
- 6 Eyepieces and eyecups
- 7 Lamp bracket mounting thread (on both sides and at rear)
- 8 Socket for connecting for the Leica L2 universal light guide (not for Leica S8 APO)
- 9 Thread for additional objective/lens shield

### Preconditions for working comfortably

- Pay great attention when setting up your stereomicroscope. You will only benefit fully from the outstanding optical and ergonomic advantages of the instrument if you set it up precisely in accordance with the directions already given.
- Arrange your workplace as well as possible, and pay attention to the heights of chair and table.
- When sitting, use the entire seat area and also the back support of the chair.
- Support your forearms.
- During work breaks, stand up and move around for exercise.

**Please also observe the note on p. 5.**

### Ergonomic viewing

The achromatic ErgoLenses for Leica S4E and the S6 models ensure an ergonomic, fatigue-free head position. The 0.6x – 0.75x ErgoLens with variable working distance of 77 – 137 mm and the 0.7x – 1x ErgoLens with variable working distance of 48 mm – 98 mm permit fine adjustment of magnification, working distance, as well as viewing height without time-consuming lens changes.

Leica S6 with 60° viewing angle offers optimal comfort at the tilted stereomicroscope.

### Interpupillary distance and exit pupil

The **interpupillary distance** can be adjusted from 55–75mm.

The **exit pupil** is the distance between the eye and eyepiece. It is

- 12mm on the 10×/23, 16×/16 and 20×/12 low eyepoint eyepieces
- 22mm on the 10×/23, 16×/15B, 25×/9.5B and 40×/6B high eyepoint eyepieces for spectacle wearers

- ▶ Carefully put your eyes against the eyepieces and push the eyepiece tubes together or apart until with both eyes you can see a single shadow-free circular field.

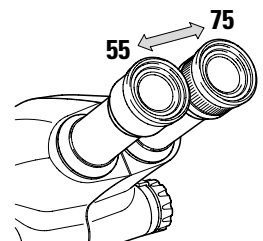
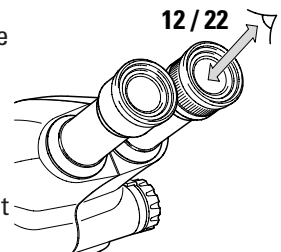

# Operating

**Eyecups** The eyepieces are supplied with detachable eyecups (see also p. 5).

If you do not wear spectacles and want the eyecups to fit snugly round your eyes:

- ▶ Attach the eyecups to the eyepieces.

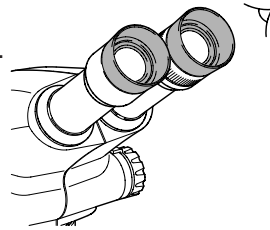

You wear spectacles for your work.

- ▶ Fold the eyecups downwards.
- The folded-down eyecups will protect your spectacle lenses against scratching.

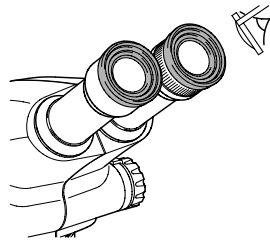

## Setting working distance and focusing

To focus the stereomicroscope, raise or lower it using the focusing drive until the desired object segment is in focus, i.e. inside the objective's working distance. The working distances of the various objectives are listed in the tables on pages 38–40.

You can operate the focusing drive with either your right or left hand.

- ▶ Position the object under the objective.
- ▶ Select the minimum magnification.
- You should select the minimum magnification because it is easier to find the desired object segment in a large field of vision.
- ▶ Look into the eyepieces.
- ▶ Focus the object by turning the pinion knob.

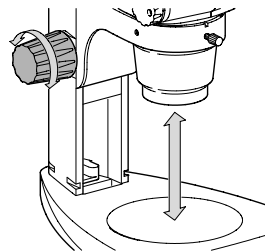



**Tension adjustment** Is the focusing drive too stiff/too loose or does the set-up slip down unassisted? You can tension the focusing drive to suit the weight of the set-up and your own needs:

- ▶ Take one pinion knob in each hand and turn in opposing directions until the desired tension is reached.

**Tilting the optics carrier to a lateral position**

The optics carrier can be tilted sideways if the user wants to work from a lateral position:

- ▶ Loosen the clamping bolt.
- ▶ Tilt the optic carrier sideways to the desired position.
- ▶ Tighten the clamping bolt.

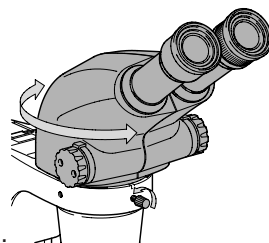

**Zoom magnification changer**

All StereoZoom® models are equipped with a continuously adjustable magnification changer that can be operated with either the right or left hand. The right-hand pinion knob carries a magnification scale. The ranges are:  
– 0.63 to 3 on the S4 E and  
– 0.63 to 4 on the S6 models  
– for S8 APO from 1 to 8

**Changing magnification**

The tables on pages 38 to 40 list the magnifications and field diameters as a function of magnification changer position and the eyepiece/objective combination being used.

- ▶ Look into the eyepieces.
- ▶ Bring the object into focus (p.24)
- ▶ Rotate the magnification changer until the desired magnification is achieved.

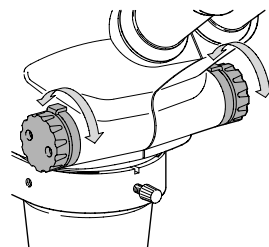

# Operating

## Setting the zoom limiter

On the S6 models and for the S8 APO it is possible to fix the maximum and minimum zoom. The same function can be used to set a fixed level of magnification.

### Example: Setting a zoom range of 1 to 3.2

1. Set the minimum zoom level at 1 using the stop on the left-hand pinion knob:

- ▶ Loosen the hexagon head screws on the left-hand pinion knob using the Allen key supplied.

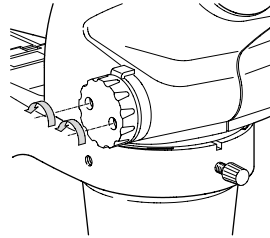

- ▶ Turn the right-hand pinion knob to 1.

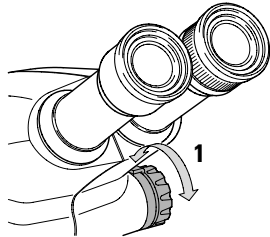

- ▶ Move the stop on the left-hand pinion knob forwards until it touches the built-in zoom stop.
- ▶ Tighten the hexagon head screws.

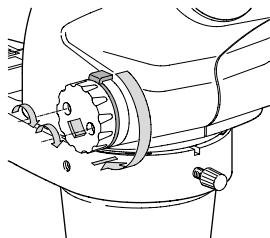

2. Set the maximum zoom level at 3.2 using the stop on the right-hand pinion knob:

- ▶ Loosen the hexagon head screws on the right-hand pinion knob.

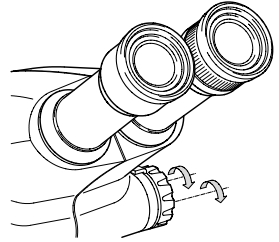

- ▶ Turn the right-hand pinion knob to 3.2.

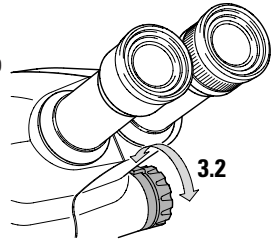

- ▶ Move the stop on the right-hand pinion knob backwards until it touches the built-in zoom stop.

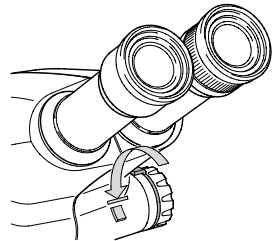

- ▶ Tighten the hexagon head screws.

# Operating

## **Diopter adjustment and setting parfocality**

If you adjust the diopters at the adjustable eyepiece as described below, the focus will remain constant, or parfocal, from minimum to maximum magnification. In other words, you will not have to refocus when you change magnification, but only when you want to examine a higher- or lower-positioned object segment. Make full use of this feature, which is not available on every stereo microscope.

- Diopter adjustment is possible within a range from +5 to -5.

Every user has to make the following adjustments only once.

If you are using a graticule, the diopter adjustment and parfocality setting procedure is slightly different to that described here. Please refer to the section on measurement in the graticule user manuals.

## **Setting up diopter with an adjustable and a fixed eyepiece**

### **Preparations**

- ▶ Set up illuminator.
- ▶ Set interpupillary distance (p.23).
- ▶ Set approximate working distance using the focusing drive (see p.38–40 for the working distances of the various objectives).

### **Bring the test object into focus**

- ▶ Position a flat test object beneath the objective.
- ▶ Set the microscope to minimum magnification.
- ▶ Close the eye that is looking into the adjustable eyepiece and look into the fixed eyepiece with the other eye.
- ▶ View the test object and bring into focus with the focusing drive.

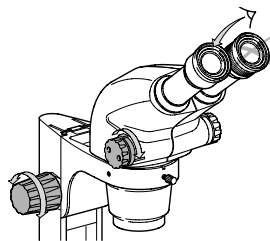

## Diopter adjustment at the adjustable eyepiece

- ▶ Without looking into the eyepieces, turn the eyelens of the adjustable eyepiece as far as possible in the “+” direction.

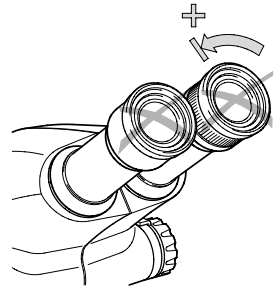

- ▶ Close the eye that is looking into the fixed eyepiece and look into the adjustable eyepiece with the other eye.
- ▶ View the test object and slowly turn the eyelens clockwise (the “-” direction) until the object is in focus.
- ▶ Set the microscope to maximum magnification.
- ▶ View the test object with both eyes and bring it into sharp focus with the focusing drive.

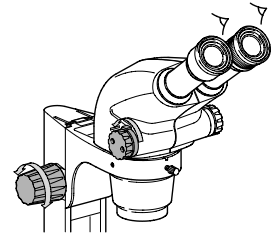
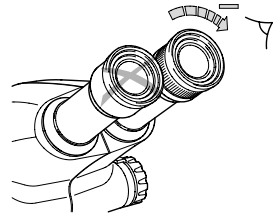

## Checking parfocality

View the object while zooming from minimum to maximum magnification.

- The object should remain in constant focus (parfocal) at all times. If it does not, please repeat the procedure above.

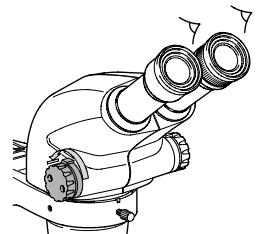

# Special notes

## Setting up diopter with two adjustable eyepieces

- Preparations**
- ▶ For Leica S6 D and S8 APO, set pinion knob to Vis position.
  - ▶ Set approximate working distance by means of focusing drive (working distances of various objectives see p.38–40).
  - ▶ Set up lighting
  - ▶ Set viewing distance (p.23).
  - ▶ Set '0' diopters on both eyepieces.

- Focusing on test object**
- ▶ Place flat test object under the objective.
  - ▶ Set lowest magnification.
  - ▶ View test object through the eyepiece and focus using the focusing drive.

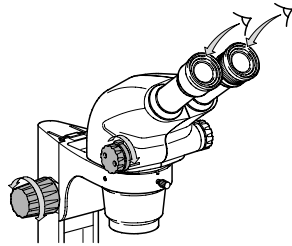

- ▶ Set highest magnification.
- ▶ Optimize sharpness using the focusing drive.

## Regulating diopters

- ▶ Set lowest magnification.
- ▶ Do not look into the eyepiece!
- ▶ Turn lens counterclockwise in the '+' direction until it stops.
- ▶ Now look into the eyepiece.
- ▶ Close one eye.
- ▶ With the other eye, observe the test object and turn the lens slowly clockwise in the '-' direction, until this eye sees the object clearly.
- ▶ Set the diopter for the other eye in the same way.

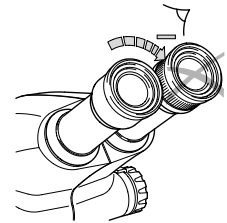
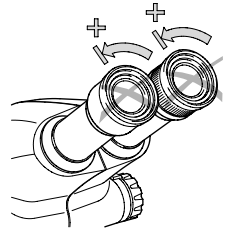

- ▶ Select highest magnification.
- ▶ View object and, if necessary, gently refocus.

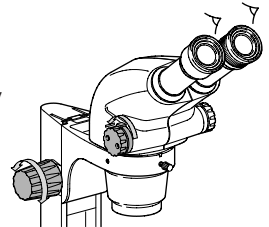

## Testing parfocality

- ▶ Adjust magnification changer from the lowest to the highest magnification.
- When doing this, the sharpness must remain constant over the entire zoom range (parfocal). Otherwise, please repeat the procedure.

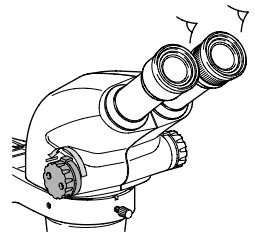

# Operating

## Photography with Leica S6 D and S8 APO

It is possible to switch between the observation and photo beam paths. Light distribution:

- in 'Vis' position: 100% light in both eyepieces/no light in the video/photo beam path
- in 'Doc' position: 100% light in the right eyepiece/no light in the left eyepiece/100% light in the video/photo beam path

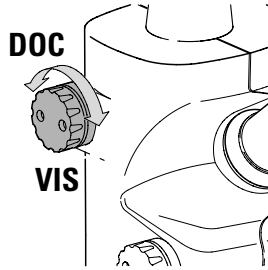

Focusing and framing down the left eyepiece (video/photo beam path).

- ▶ When the picture detail and sharpness are set to your satisfaction, switch to the 'Doc' position and take your photo.



Please note: Images of flat specimen are partly unsharp (left and right edge).



# Special notes

**What do I do if ...** ... the field of vision is in shadow?

- Remedy**
- Adjust interpupillary distance and ensure that it is correct (p.23).
  - Check pupil position (p.23).

... the image will not stay in focus?

- Remedy**
- Insert eyepieces correctly (p.16).
  - Correct diopter adjustment exactly as described (p.28–31).

... the focusing drive slides down or is difficult to turn?

- Remedy**
- Adjust tension (p.24).

If you encounter problems with electrically powered equipment, first check:

- that the voltage selector is set to the correct voltage.
- that the mains power switch is in the 'on' position.
- that the mains power cable is correctly connected.
- that all connector cables are correctly connected.
- that none of the fuses have blown.

... the image is too dark?

- Remedy**
- Set regulating knob high enough.

Photographs are blurred.

- Remedy**
- Focus precisely (p.24).
  - Focus on reticles and carry out diopters-correction exactly according to the instructions (p.30).
  - Insert eyepieces all the way in (p.16).
  - Check that the reticles are firmly placed in the eyepiece (p.18).

No image on the film

- Remedy**
- Switch light divider on the photo tube to the 'Doc' position (p.32).

# Care

In this section we would like to explain how you can take care of your microscope and give you a few tips on cleaning.

- Protect your microscope**
- against moisture, vapours, acids, alkalis and caustic substances.

Never keep chemicals close to your microscope.

- against improper handling.

Never fit other equipment connectors or dismantle optical systems and mechanical parts unless the user manual gives express instructions for doing so.

- against oil and grease.

Never grease guides and mechanical parts.

- Dust and dirt impair your results.**
- Therefore:**
- Cover your microscope with its dust cover during breaks.
  - Put dust covers over tube openings, eyepieces, and eyepiece tubes without eyepieces.
  - Remove dust with a rubber blower and soft brush.
  - Clean eyepieces and objectives with special optical cleaning cloths and pure alcohol.
  - Keep accessories in a dust-free environment when not in use.

**Cleaning plastic parts**

Various components are made of plastic or are plastic-coated to make them pleasant to touch and handle. However, incorrect cleaning with unsuitable detergents can damage the plastic. Please observe the following do's and don'ts:

**Never clean plastics**

- in an ultrasonic cleaner. The plastic may become brittle and eventually break.
- with caustic or acetone-containing substances such as ether substitute.
- with any other solvents except ethanol and isopropanol.

**To clean plastics safely use**

- warm soapy water, rinsing the plastic afterwards with distilled water.
- ethanol (industrial alcohol) and isopropanol.



Always take appropriate safety precautions when using ethanol and isopropanol.

## Special notes

**We guarantee quality**    **You are working with a high-performance precision instrument, whose quality we guarantee.**

**The warranty covers manufacturing and materials faults, but not damage resulting from negligence or incorrect handling.**

If you treat your valuable optical instrument with due care, it will repay you with the decades of reliable precision for which Leica instruments are renowned.

However, should you encounter problems with your microscope at any time, please contact your local Leica representative or Leica Microsystems (Switzerland) Ltd., CH-9435 Heerbrugg.

**Calculating total magnification and field diameter**

- M<sub>O</sub>** Objective magnification
- M<sub>E</sub>** Eyepiece magnification
- z** Magnification changer setting
- N<sub>FOV</sub>** Eyepiece field number. Field numbers are printed on the eyepieces:  
10×/23, 16×/16, 20×/12, 10×/23B, 16×/14B, 25×/9.5B, 40×/6B

**Example:**

- M<sub>O</sub>** 1.6× objective
- M<sub>E</sub>** 20×/12 eyepiece
- z** Zoom position 4.0

**Magnification in the binocular tube:**

$$M_{TOT\ VIS} = M_O \times M_E \times z \quad 1.6 \times 20 \times 4 = 128$$

**Field diameter in the object:**

$$\varnothing_{OF} = \frac{N_{FOV}}{M_O \times z} = \frac{12}{1.6 \times 4} = 1.9\text{mm}$$

# Optical Data, Leica S4 E, S6 E, S6, S6 T, S6 D

				with additional objectives									
Working distance		110mm		300mm		200mm		155mm		130mm		55mm	
Eyepieces	Zoom position *4.0: S6	Total magnification	Field diameter mm	0.32×		0.5×		0.63×		0.75×		1.6×	
				Total magnification	Field diameter mm	Total magnification	Field diameter mm	Total magnification	Field diameter mm	Total magnification	Field diameter mm	Total magnification	Field diameter mm
10 446 332 10 446 333 10×/23 10×/23B 10 446 326 10 446 329	0.63	6.3	36.5	2.0	115.0	3.2	71.9	4.0	57.5	4.7	48.9	10.1	22.8
	0.8	8.0	28.8	2.6	88.5	4.0	57.5	5.0	46.0	6.0	38.3	12.8	18.0
	1.0	10.0	23.0	3.2	71.9	5.0	46.0	6.3	36.5	7.5	30.7	16.0	14.4
	1.25	12.5	18.4	4.0	57.5	6.3	36.5	7.9	29.1	9.4	24.5	20.0	11.5
	1.6	16.0	14.4	5.1	45.1	8.0	28.8	10.1	22.8	12.0	19.2	25.6	9.0
	2.0	20.0	11.5	6.4	35.9	10.0	23.0	12.6	18.3	15.0	15.3	32.0	7.2
	2.5	25.0	9.2	8.0	28.8	12.5	18.4	15.8	14.6	18.8	12.2	40.0	5.8
	3.2	32.0	7.2	10.2	22.5	16.0	14.4	20.2	11.4	24.0	9.6	51.2	4.5
	4.0*	40.0	5.8	12.8	18.0	20.0	11.5	25.2	9.1	30.0	7.7	64.0	3.6
	16×/16 10 446 354 10 446 355	0.63	10.1	25.3	3.2	80.0	5.0	51.2	6.4	40.0	7.6	33.7	16.1
0.8		12.8	20.0	4.1	62.4	6.4	40.0	8.1	31.6	9.6	26.7	20.5	12.5
1.0		16.0	16.0	5.1	50.2	8.0	32.0	10.1	25.3	12.0	21.3	25.6	10.0
1.25		20.0	12.8	6.4	40.0	10.0	25.6	12.6	20.3	15.0	17.1	32.0	8.0
1.6		25.6	10.0	8.2	31.2	12.8	20.0	16.1	15.9	19.2	13.3	41.0	6.2
2.0		32.0	8.0	10.2	25.1	16.0	16.0	20.2	12.7	24.0	10.7	51.2	5.0
2.5		40.0	6.4	12.8	20.0	20.0	12.8	25.2	10.2	30.0	8.5	64.0	4.0
3.2		51.2	5.0	16.4	15.6	25.6	10.0	32.3	7.9	38.4	6.7	81.9	3.1
4.0*		64.0	4.0	20.5	12.5	32.0	8.0	40.3	6.4	48.0	5.3	102.4	2.5
20×/12 10 446 356 10 446 357		0.63	12.6	19.0	4.0	60.0	6.3	38.1	7.9	30.4	9.5	25.3	20.2
	0.8	16.0	15.0	5.1	47.1	8.0	30.0	10.1	23.8	12.0	20.0	25.6	9.4
	1.0	20.0	12.0	6.4	37.5	10.0	24.0	12.6	19.0	15.0	16.0	32.0	7.5
	1.25	25.0	9.6	8.0	30.0	12.5	19.2	15.8	15.2	18.8	12.8	40.0	6.0
	1.6	32.0	7.5	10.2	23.5	16.0	15.0	20.2	11.9	24.0	10.0	51.2	4.7
	2.0	40.0	6.0	12.8	18.8	20.0	12.0	25.2	9.5	30.0	8.0	64.0	3.8
	2.5	50.0	4.8	16.0	15.0	25.0	9.6	31.5	7.6	37.5	6.4	80.0	3.0
	3.2	64.0	3.8	20.5	11.7	32.0	7.5	40.3	6.0	48.0	5.0	102.4	2.3
	4.0*	80.0	3.0	25.6	9.4	40.0	6.0	50.4	4.8	60.0	4.0	128.0	1.9
	16×/14B 10 445 301	0.63	10.1	22.2	3.2	70.0	5.0	44.8	6.4	35.0	7.6	29.5	16.1
0.8		12.8	17.5	4.1	54.6	6.4	35.0	8.1	27.7	9.6	23.3	20.5	10.9
1.0		16.0	14.0	5.1	43.9	8.0	28.0	10.1	22.2	12.0	18.7	25.6	8.8
1.25		20.0	11.2	6.4	35.0	10.0	22.4	12.6	17.8	15.0	14.9	32.0	7.0
1.6		25.6	8.8	8.2	27.3	12.8	17.5	16.1	13.9	19.2	11.7	41.0	5.5
2.0		32.0	7.0	10.2	22.0	16.0	14.0	20.2	11.1	24.0	9.3	51.2	4.4
2.5		40.0	5.6	12.8	17.5	20.0	11.2	25.2	8.9	30.0	7.5	64.0	3.5
3.2		51.2	4.4	16.4	13.7	25.6	8.8	32.3	6.9	38.4	5.8	81.9	2.7
4.0*		64.0	3.5	20.5	10.9	32.0	7.0	40.3	5.6	48.0	4.7	102.4	2.2
25×/9.5B 10 445 302		0.63	15.8	15.0	5.0	47.5	7.9	30.1	9.9	24.0	11.8	20.1	25.2
	0.8	20.0	11.9	6.4	37.1	10.0	23.8	12.6	18.8	15.0	15.8	32.0	7.4
	1.0	25.0	9.5	8.0	29.7	12.5	19.0	15.8	15.0	18.8	12.6	40.0	5.9
	1.25	31.3	7.6	10.0	23.8	15.6	15.2	19.7	12.1	23.4	10.1	50.0	4.8
	1.6	40.0	5.9	12.8	18.6	20.0	11.9	25.2	9.4	30.0	7.9	64.0	3.7
	2.0	50.0	4.8	16.0	14.8	25.0	9.5	31.5	7.5	37.5	6.3	80.0	3.0
	2.5	62.5	3.8	20.0	11.9	31.3	7.6	39.4	6.0	46.9	5.1	100.0	2.4
	3.2	80.0	3.0	25.6	9.3	40.0	5.9	50.4	4.7	60.0	4.0	128.0	1.9
	4.0*	100.0	2.4	32.0	7.4	50.0	4.8	63.0	3.8	75.0	3.2	160.0	1.5
	40×/6B 10 445 303	0.63	25.2	9.5	8.1	29.6	12.6	19.0	15.9	15.1	18.9	12.7	40.3
0.8		32.0	7.5	10.2	23.5	16.0	15.0	20.2	11.9	24.0	10.0	51.2	4.7
1.0		40.0	6.0	12.8	18.8	20.0	12.0	25.2	9.5	30.0	8.0	64.0	3.8
1.25		50.0	4.8	16.0	15.0	25.0	9.6	31.5	7.6	37.5	6.4	80.0	3.0
1.6		64.0	3.8	20.5	11.7	32.0	7.5	40.3	6.0	48.0	5.0	102.4	2.3
2.0		80.0	3.0	25.6	9.4	40.0	6.0	50.4	4.8	60.0	4.0	128.0	1.9
2.5		100.0	2.4	32.0	7.5	50.0	4.8	63.0	3.8	75.0	3.2	160.0	1.5
3.2		128.0	1.9	41.0	5.9	64.0	3.8	80.6	3.0	96.0	2.5	204.8	1.2
4.0*		160.0	1.5	51.2	4.7	80.0	3.0	100.8	2.4	120.0	2.0	256.0	0.9

with additional objectives													
2.0×		0.3×–0.4×		0.3×–0.4×		0.6×–0.75×		0.6×–0.75×		0.7×–1.0×		0.7×–1.0×	
35mm		200mm		350mm		77mm		137mm		48mm		98mm	
Total magnification	Field diameter mm	Total magnification	Field diameter mm	Total magnification	Field diameter mm	Total magnification	Field diameter mm	Total magnification	Field diameter mm	Total magnification	Field diameter mm	Total magnification	Field diameter mm
12.6	18.3	2.5	92.0	1.8	127.8	4.7	48.9	3.5	65.7	6.2	37.1	4.5	51.1
16.0	14.4	3.1	74.2	2.2	104.5	6.0	38.3	4.5	51.1	7.9	29.1	5.7	40.4
20.0	11.5	3.9	59.0	2.8	82.1	7.5	30.7	5.6	41.1	9.9	23.2	7.1	32.4
25.0	9.2	4.9	46.9	3.5	65.7	9.4	24.5	7.0	32.9	12.4	18.5	8.9	25.8
32.0	7.2	6.2	37.1	4.5	51.1	12.0	19.2	9.0	25.6	15.8	14.6	11.4	20.2
40.0	5.8	7.8	29.5	5.6	41.1	15.0	15.3	11.2	20.5	19.8	11.6	14.2	16.2
50.0	4.6	9.8	23.5	7.0	32.9	18.8	12.2	14.0	16.4	24.8	9.3	17.8	12.9
64.0	3.6	12.5	18.4	9.0	25.6	24.0	9.6	17.9	12.8	31.7	7.3	22.7	10.1
80.0	2.9	15.6	14.7	11.2	20.5	30.0	7.7	22.4	10.3	39.6	5.8	28.4	8.1
20.2	12.7	3.9	65.6	2.8	91.4	7.6	33.7	5.6	45.7	10.0	25.6	7.2	35.6
25.6	10.0	5.0	51.2	3.6	71.1	9.6	26.7	7.2	35.6	12.7	20.2	9.1	28.1
32.0	8.0	6.2	41.3	4.5	56.9	12.0	21.3	9.0	28.4	15.8	16.2	11.4	22.5
40.0	6.4	7.8	32.8	5.6	45.7	15.0	17.1	11.2	22.9	19.8	12.9	14.2	18.0
51.2	5.0	10.0	25.6	7.2	35.6	19.2	13.3	14.3	17.9	25.3	10.1	18.2	14.1
64.0	4.0	12.5	20.5	9.0	28.4	24.0	10.7	17.9	14.3	31.7	8.1	22.7	11.3
80.0	3.2	15.6	16.4	11.2	22.9	30.0	8.5	22.4	11.4	39.6	6.5	28.4	9.0
102.4	2.5	20.0	12.8	14.3	17.9	38.4	6.7	28.7	8.9	50.7	5.0	36.4	7.0
128.0	2.0	25.0	10.2	17.9	14.3	48.0	5.3	35.8	7.2	63.4	4.0	45.4	5.6
25.2	9.5	4.9	49.0	3.5	68.6	9.5	25.3	7.1	33.8	12.5	19.2	8.9	27.0
32.0	7.5	6.2	38.7	4.5	53.3	12.0	20.0	9.0	26.7	15.8	15.2	11.4	21.1
40.0	6.0	7.8	30.8	5.6	42.9	15.0	16.0	11.2	21.4	19.8	12.1	14.2	16.9
50.0	4.8	9.8	24.5	7.0	34.3	18.8	12.8	14.0	17.1	24.8	9.7	17.8	13.5
64.0	3.8	12.5	19.2	9.0	26.7	24.0	10.0	17.9	13.4	31.7	7.6	22.7	10.6
80.0	3.0	15.6	15.4	11.2	21.4	30.0	8.0	22.4	10.7	39.6	6.1	28.4	8.5
100.0	2.4	19.5	12.3	14.0	17.1	37.5	6.4	28.0	8.6	49.5	4.8	35.5	6.8
128.0	1.9	25.0	9.6	17.9	13.4	48.0	5.0	35.8	6.7	63.4	3.8	45.4	5.3
160.0	1.5	31.2	7.7	22.4	10.7	60.0	4.0	44.8	5.4	79.2	3.0	56.8	4.2
20.2	11.1	3.9	57.4	2.8	80.0	7.6	29.5	5.6	40.0	10.0	22.4	7.2	31.1
25.6	8.8	5.0	44.8	3.6	62.2	9.6	23.3	7.2	31.1	12.7	17.6	9.1	24.6
32.0	7.0	6.2	36.1	4.5	49.8	12.0	18.7	9.0	24.9	15.8	14.2	11.4	19.6
40.0	5.6	7.8	28.7	5.6	40.0	15.0	14.9	11.2	20.0	19.8	11.3	14.2	15.8
51.2	4.4	10.0	22.4	7.2	31.1	19.2	11.7	14.3	15.7	25.3	8.9	18.2	12.3
64.0	3.5	12.5	17.9	9.0	24.9	24.0	9.3	17.9	12.5	31.7	7.1	22.7	9.9
80.0	2.8	15.6	14.4	11.2	20.0	30.0	7.5	22.4	10.0	39.6	5.7	28.4	7.9
102.4	2.2	20.0	11.2	14.3	15.7	38.4	5.8	28.7	7.8	50.7	4.4	36.4	6.2
128.0	1.8	25.0	9.0	17.9	12.5	48.0	4.7	35.8	6.3	63.4	3.5	45.4	4.9
31.5	7.5	6.1	38.9	4.4	54.0	11.8	20.1	8.8	27.0	15.6	15.2	11.2	21.2
40.0	5.9	7.8	30.4	5.6	42.4	15.0	15.8	11.2	21.2	19.8	12.0	14.2	16.7
50.0	4.8	9.8	24.2	7.0	33.9	18.8	12.6	14.0	17.0	24.8	9.6	17.8	13.3
62.5	3.8	12.2	19.5	8.8	27.0	23.4	10.1	17.5	13.6	30.9	7.7	22.2	10.7
80.0	3.0	15.6	15.2	11.2	21.2	30.0	7.9	22.4	10.6	39.6	6.0	28.4	8.4
100.0	2.4	19.5	12.2	14.0	17.0	37.5	6.3	28.0	8.5	49.5	4.8	35.5	6.7
125.0	1.9	24.4	9.7	17.5	13.6	46.9	5.1	35.0	6.8	61.9	3.8	44.4	5.3
160.0	1.5	31.2	7.6	22.4	10.6	60.0	4.0	44.8	5.3	79.2	3.0	56.8	4.2
200.0	1.2	39.0	6.1	28.0	8.5	75.0	3.2	56.0	4.2	99.0	2.4	71.0	3.3
50.4	4.8	9.8	24.5	7.1	33.8	18.9	12.7	14.1	17.0	24.9	9.6	17.9	13.4
64.0	3.8	12.5	19.2	9.0	26.7	24.0	10.0	17.9	13.4	31.7	7.6	22.7	10.6
80.0	3.0	15.6	15.4	11.2	21.4	30.0	8.0	22.4	10.7	39.6	6.1	28.4	8.5
100.0	2.4	19.5	12.3	14.0	17.1	37.5	6.4	28.0	8.6	49.5	4.8	35.5	6.8
128.0	1.9	25.0	9.6	17.9	13.4	48.0	5.0	35.8	6.7	63.4	3.8	45.4	5.3
160.0	1.5	31.2	7.7	22.4	10.7	60.0	4.0	44.8	5.4	79.2	3.0	56.8	4.2
200.0	1.2	39.0	6.2	28.0	8.6	75.0	3.2	56.0	4.3	99.0	2.4	71.0	3.4
256.0	0.9	49.9	4.8	35.8	6.7	96.0	2.5	71.7	3.3	126.7	1.9	90.9	2.6
320.0	0.8	62.4	3.8	44.8	5.4	120.0	2.0	89.6	2.7	158.4	1.5	113.6	2.1

# Optical Data, StereoZoom® S8 APO

				Achromats						Achromate	
				0.63x		1.6x		2.0x		0.32x	
Working distance		75mm		101mm		37mm		25mm		200mm	
Eyepieces	Zoom position	Total magnification	Field diameter mm	Total magnification	Field diameter mm	Total magnification	Field diameter mm	Total magnification	Field diameter mm	Total magnification	Field diameter mm
10 446 332 10 446 333  10x/23 10x/23B  10 446 326 10 446 329	1.0	10.0	23.0	6.3	36.5	16.0	14.4	20.0	11.5	3.2	71.9
	1.25	12.5	18.4	7.9	29.1	20.0	11.5	25.0	9.2	4.0	57.5
	1.6	16.0	14.4	10.1	22.8	25.6	9.0	32.0	7.2	5.1	45.1
	2.0	20.0	11.5	12.6	18.3	32.0	7.2	40.0	5.8	6.4	35.9
	2.5	25.0	9.2	15.8	14.6	40.0	5.8	50.0	4.6	8.0	28.8
	3.2	32.0	7.2	20.2	11.4	51.2	4.5	64.0	3.6	10.2	22.5
	4.0	40.0	5.8	25.2	9.1	64.0	3.6	80.0	2.9	12.8	18.0
	5.0	50.0	4.6	31.5	7.3	80.0	2.9	100.0	2.3	16.0	14.4
	6.3	63.0	3.7	39.7	5.8	100.8	2.3	126.0	1.8	20.2	11.4
	8.0	80.0	2.9	50.4	4.6	128.0	1.8	160.0	1.4	25.6	9.0
16x/16  10 446 354 10 446 355	1.0	16.0	16.0	10.1	25.3	25.6	10.0	32.0	8.0	5.1	43.9
	1.25	20.0	12.8	12.6	20.3	32.0	8.0	40.0	6.4	6.4	35.0
	1.6	25.6	10.0	16.1	15.9	41.0	6.2	51.2	5.0	8.2	27.3
	2.0	32.0	8.0	20.2	12.7	51.2	5.0	64.0	4.0	10.2	22.0
	2.5	40.0	6.4	25.2	10.2	64.0	4.0	80.0	3.2	12.8	17.5
	3.2	51.2	5.0	32.3	7.9	81.9	3.1	102.4	2.5	16.4	13.7
	4.0	64.0	4.0	40.3	6.4	102.4	2.5	128.0	2.0	20.5	10.9
	5.0	80.0	3.2	50.4	5.1	128.0	2.0	160.0	1.6	25.6	8.8
	6.3	100.8	2.5	63.5	4.0	161.3	1.6	201.6	1.3	32.3	6.9
	8.0	128.0	2.0	80.6	3.2	204.8	1.3	256.0	1.0	41.0	5.5
25x/9.5B  10 445 302	1.0	25.0	9.5	15.8	15.0	40.0	5.9	50.0	4.8	8.0	29.7
	1.25	31.3	7.6	19.7	12.1	50.0	4.8	62.5	3.8	10.0	23.8
	1.6	40.0	5.9	25.2	9.4	64.0	3.7	80.0	3.0	12.8	18.6
	2.0	50.0	4.8	31.5	7.5	80.0	3.0	100.0	2.4	16.0	14.8
	2.5	62.5	3.8	39.4	6.0	100.0	2.4	125.0	1.9	20.0	11.9
	3.2	80.0	3.0	50.4	4.7	128.0	1.9	160.0	1.5	25.6	9.3
	4.0	100.0	2.4	63.0	3.8	160.0	1.5	200.0	1.2	32.0	7.4
	5.0	125.0	1.9	78.8	3.0	200.0	1.2	250.0	1.0	40.0	5.9
	6.3	157.5	1.5	99.2	2.4	252.0	0.9	315.0	0.8	50.4	4.7
	8.0	200.0	1.2	126.0	1.9	320.0	0.7	400.0	0.6	64.0	3.7
40x/6B  10 445 303	1.0	40.0	6.0	25.2	9.5	64.0	3.8	80.0	3.0	12.8	18.8
	1.25	50.0	4.8	31.5	7.6	80.0	3.0	100.0	2.4	16.0	15.0
	1.6	64.0	3.8	40.3	6.0	102.4	2.3	128.0	1.9	20.5	11.7
	2.0	80.0	3.0	50.4	4.8	128.0	1.9	160.0	1.5	25.6	9.4
	2.5	100.0	2.4	63.0	3.8	160.0	1.5	200.0	1.2	32.0	7.5
	3.2	128.0	1.9	80.6	3.0	204.8	1.2	256.0	0.9	41.0	5.9
	4.0	160.0	1.5	100.8	2.4	256.0	0.9	320.0	0.8	51.2	4.7
	5.0	200.0	1.2	126.0	1.9	320.0	0.8	400.0	0.6	64.0	3.8
	6.3	252.0	1.0	158.8	1.5	403.2	0.6	504.0	0.5	80.6	3.0
	8.0	320.0	0.8	201.6	1.2	512.0	0.5	640.0	0.4	102.4	2.3



# Dimensions, Leica S4 E, S6 E, S6 T

with incident-light stand

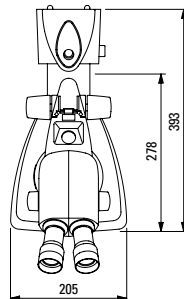
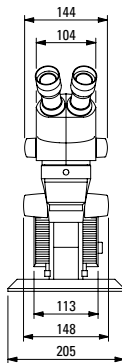
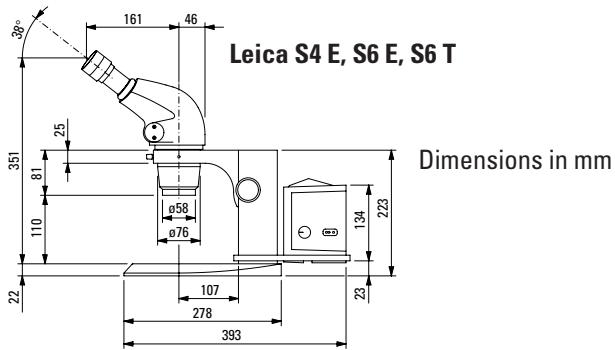

# Dimensions, Leica S4 E, S6 E, S6 T

with transmitted-light stand

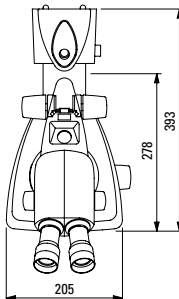
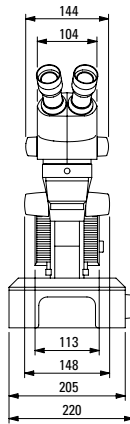
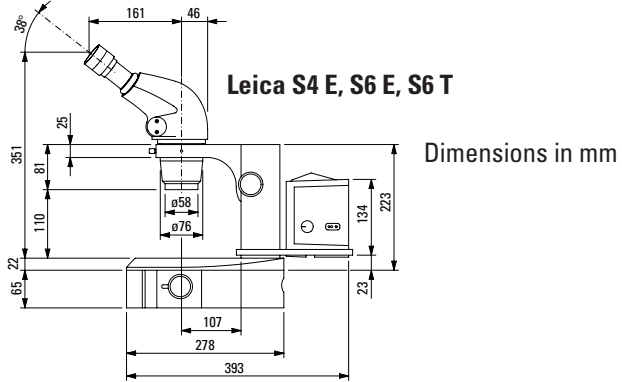

# Dimensions, Leica S6

with inclining focusing drive

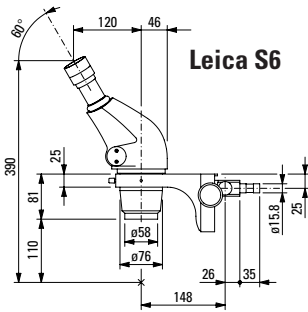

Leica S6

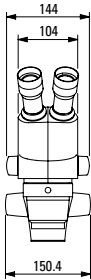

Dimensions in mm

# Dimensions, Leica S6 D

with incident-light stand

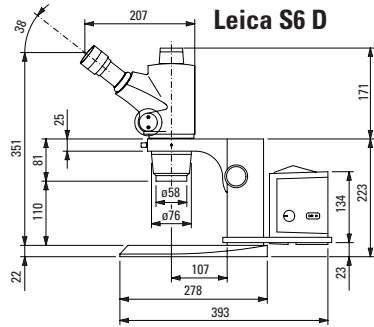

Leica S6 D

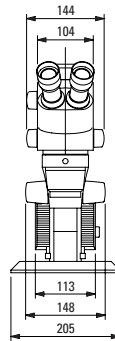

Dimensions in mm

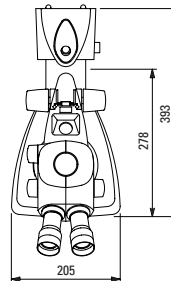





# Dimensions, Leica S8 APO

with transmitted-light stand

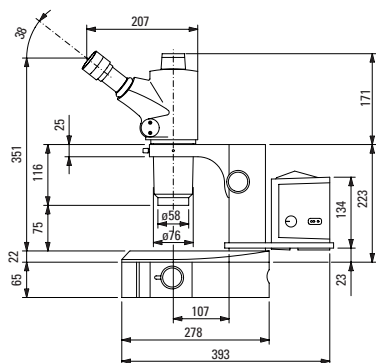

**Leica S8 APO**

Dimensions in mm

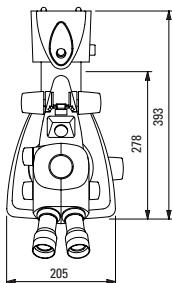
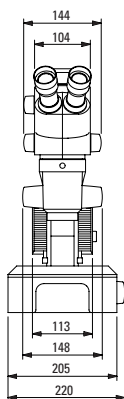

# Leica Microsystems worldwide

Leica Microsystems is active in microscopy, sample preparation, image analysis, confocal laser technology, medical equipment and equipment for the semiconductor industry. With headquarters in Wetzlar, Germany, this international technology group has grown from five companies with a long tradition – Wild, Leitz, Reichert, Jung and Cambridge Instruments.

**Made by Leica** Leica Microsystems develops high-utility end-to-end solutions and innovative cutting-edge technologies of internationally renowned quality. The same high quality standards are in force in each of the Group's 11 production sites in seven countries, making the name Leica synonymous with quality.

**Leica for you** Technology is one key factor in the success of Leica Microsystems, customer focus the other. Our friendly staff offer competent, on-the-spot advice and service in your own language. Naturally we also cater reliably and without fuss for all customer wishes and ensure that your goods arrive on time and in perfect condition.

**[www.stereozoom.com](http://www.stereozoom.com)** You will find valuable information on the products and services of Leica Microsystems on the Internet as well as contact information for distributors near you. Visit us to get more information on the new StereoZoom® line.

# Leica Microsystems – the brand for outstanding products

Leica Microsystems' mission is to be the world's first-choice provider of innovative solutions to our customers' needs for vision, measurement, lithography and analysis of microstructures.

Leica, the leading brand for microscopes and scientific instruments, developed from five brand names, all with a long tradition: Wild, Leitz, Reichert, Jung and Cambridge Instruments. Yet Leica symbolizes innovation as well as tradition.

## Leica Microsystems – an international company with a strong network of customer services

Australia:	Gladesville, NSW	Tel. +1 800 625 286	Fax +61 2 9817 8358
Austria:	Vienna	Tel. +43 1 486 80 50 0	Fax +43 1 486 80 50 30
Canada:	Richmond Hill/Ontario	Tel. +1 905 762 20 00	Fax +1 905 762 89 37
China:	Hong Kong	Tel. +8522 564 6699	Fax +8522 564 4163
Denmark:	Herlev	Tel. +45 44 5401 01	Fax +45 44 5401 11
France:	Rueil-Malmaison		
	Cédex	Tel. +33 1 4732 8585	Fax +33 1 4732 8586
Germany:	Bensheim	Tel. +49 6251 1360	Fax +49 6251 136 155
Italy:	Milan	Tel. +39 02 57 486 1	Fax +39 02 5740 3273
Japan:	Tokyo	Tel. +81 3 543 596 09	Fax +81 3 543 596 15
Korea:	Seoul	Tel. +82 2 514 6543	Fax +82 2 514 6548
Netherlands:	Rijswijk	Tel. +31 70 41 32 130	Fax +31 70 41 32 109
Portugal:	Lisbon	Tel. +35 1 213 814 766	Fax +35 1 213 854 668
Singapore:		Tel. +65 6 77 97 823	Fax +65 6 77 30 628
Spain:	Barcelona	Tel. +34 93 494 9530	Fax +34 93 494 9532
Sweden:	Sollentuna	Tel. +46 8 625 45 45	Fax +46 8 625 45 10
Switzerland:	Glattbrugg	Tel. +41 44 809 34 34	Fax +41 44 809 34 44
United Kingdom:	Milton Keynes	Tel. +44 1908 246 246	Fax +44 1908 609 992
USA:	Bannockburn/Illinois	Tel. +1 800 248 0123	Fax +1 847 405 0164

and representatives of Leica Microsystems  
in more than 100 countries.

In accordance with the ISO 9001 certificate, Leica Microsystems (Switzerland) Ltd, Business Unit Stereo & Microscope Systems has at its disposal a management system that meets the requirements of the international standard for quality management. In addition, production meets the requirements of the international standard ISO 14001 for environmental management.

Leica Microsystems (Switzerland) Ltd  
Stereo & Microscope Systems  
CH-9435 Heerbrugg  
Telephone +41 71 726 33 33  
Fax +41 71 726 33 99  
www.leica-microsystems.com  
www.stereomicroscopy.com

The companies of the Leica Microsystems Group operate internationally in four business segments, where we rank with the market leaders.

### ● Microscopy Systems

Our expertise in microscopy is the basis for all our solutions for visualization, measurement and analysis of microstructures in life sciences and industry. With confocal laser technology and image analysis systems, we provide three-dimensional viewing facilities and offer new solutions for cytogenetics, pathology and materials sciences.

### ● Specimen Preparation

We provide comprehensive systems and services for clinical histo- and cytopathology applications, biomedical research and industrial quality assurance. Our product range includes instruments, systems and consumables for tissue infiltration and embedding, microtomes and cryostats as well as automated stainers and coverslippers.

### ● Medical Equipment

Innovative technologies in our surgical microscopes offer new therapeutic approaches in microsurgery.

### ● Semiconductor Equipment

Our automated, leading-edge measurement and inspection systems and our E-beam lithography systems make us the first choice supplier for semiconductor manufacturers all over the world.

**Leica**  
MICROSYSTEMS